

LSH 6355P

5 AMP DC-TO-DC MICROCONVERTER

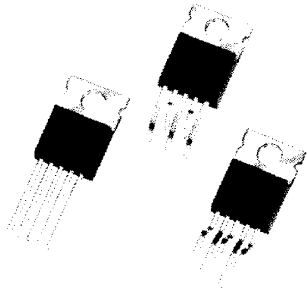

FEATURES

- Complete DC-to-DC converter
- 70% minimum efficiency
- 70kHz switching frequency
- Programmable output voltage from 5 to 27 Volts
- Preset output voltage of 5.05 Volts $\pm 1.5\%$
- Current limit and thermal shutdown

DESCRIPTION

The LSH 6355P switching regulator is a micro-hybrid circuit designed for use in step-down applications requiring accurate output voltages over combined variations of line, load and temperature. This unique product greatly simplifies switching power supply design. The LSH 6355P micro-converter includes a switching regulator, catch diode and compensation network within a TO-220 style package. Just add a choke and two capacitors to obtain an efficient DC-to-DC converter for 5 Volts at 5 Amps. To increase the output voltage, simply add a programming resistor. The current limit and thermal shutdown features of the LSH 6355P fully protect the device against overstress conditions.

ABSOLUTE MAXIMUM RATINGS

PARAMETER	SYMBOL	MAXIMUM	UNITS
Input Voltage	V_{IN}	35	Volts
Power Dissipation	P_D	Internally Limited	Watts
Thermal Resistance Junction to Case	θ_{JC}	4.5	$^{\circ}C/W$
Operating Junction and Storage Temperature Range	T_J T_{STG}	- 25 to 125	$^{\circ}C$
Lead Temperature (Soldering, 10 Seconds)	T_{LEAD}	260	$^{\circ}C$

DEVICE SELECTION GUIDE

DEVICE	LEAD CONFIGURATION
LSH 6355P	straight in-line
LSH 6355PV	vertical staggered
LSH 6355PH	horizontal staggered

BLOCK DIAGRAM

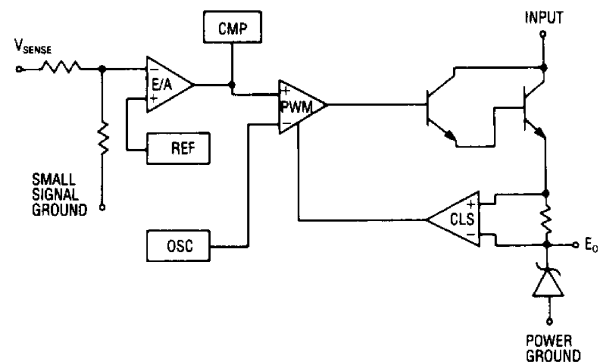

The LSH 6355P TO-220 style plastic package is available in three options to accommodate various mounting requirements. Available lead formations are straight in-line, staggered for vertical mount and staggered for horizontal mount.

ELECTRICAL CHARACTERISTICS

Input test conditions are as follows: $V_{IN} = 24\text{VDC}$, $V_O = 5\text{VDC}$,
 $I_O = 5\text{A}$, $T_J = 25^\circ\text{C}$, unless otherwise specified.

Parameter	Symbol	Test Conditions			Test Limits			Units
		V_{IN}	I_O	T_J	Minimum	Typical	Maximum	
Output Voltage ¹	V_O	12V to 35V	0A 0.5A to 5A	-25 to 125°C	4.97 4.80	5.05	5.13 5.30	Volts
Line Regulation ¹	$REG_{(LINE)}$	12V to 35V				90		mV
Load Regulation ¹	$REG_{(LOAD)}$		0.5A to 5A			45		mV
System Efficiency	η			-25 to 125°C	70	75		%
Switching Frequency	f_{SX}		50mA		58	70	86	kHz
Quiescent Current	I_Q	35V	0A			18	30	mA
Peak Current Limit Threshold	I_{CL}			-25 to 125°C	5.5		9	Amps
Output Noise and Ripple	V_N	$30V + 5V_{pk-pk}^4$				50		mV_{pk-pk}
Turn On Overshoot			0.5A to 5A			0		mV
Unit Step Load Change			0A to 5A 5A to 0.05A			0 250 ²		mV mV_{pk}
Programming Resistance ³		12V to 35V		-25 to 125°C		0.2		Volts/k Ω

⁽¹⁾Low duty cycle, pulse testing with Kelvin connections required.

⁽²⁾10mS duration.

⁽³⁾ V_O programming above 5.05V to 27V.

⁽⁴⁾120 Hz input ripple.

TYPICAL APPLICATION

DC-TO-DC STEP-DOWN CONVERTER^{1,2}

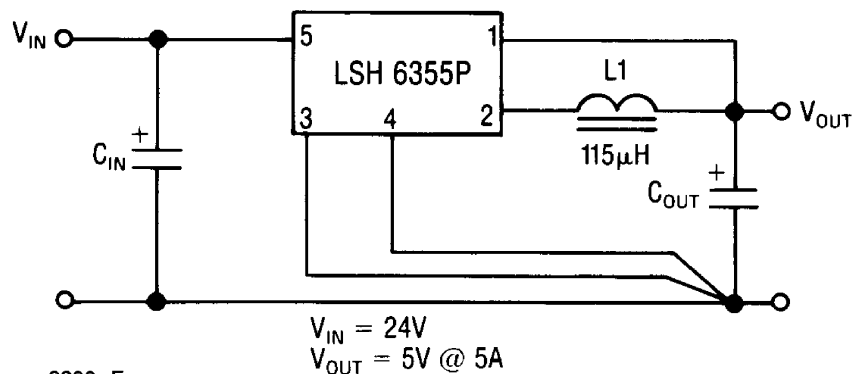

¹ $C_{IN} = 470\mu\text{F}$; $C_{OUT} = 2200\mu\text{F}$

² For output voltages above 5V, add programming resistor between Pin 1 and V_{OUT} .

OPERATIONAL DATA

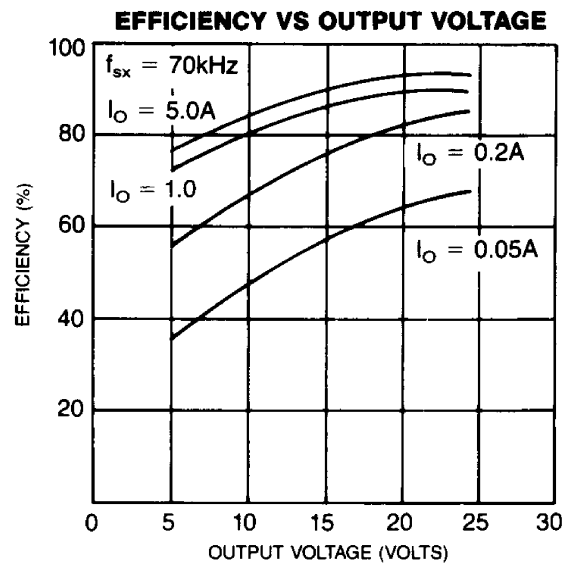
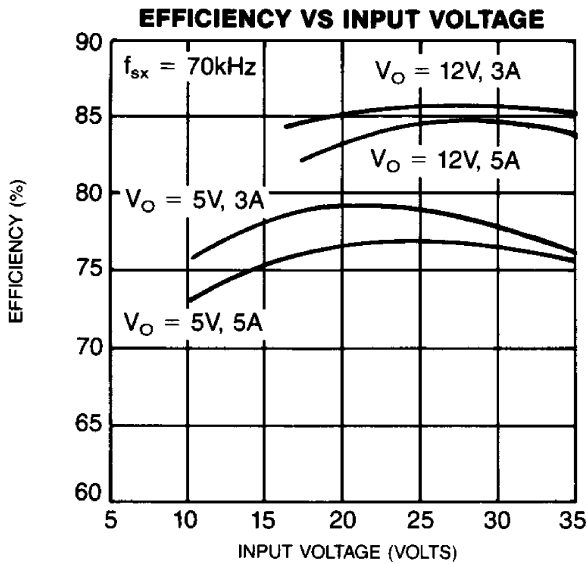
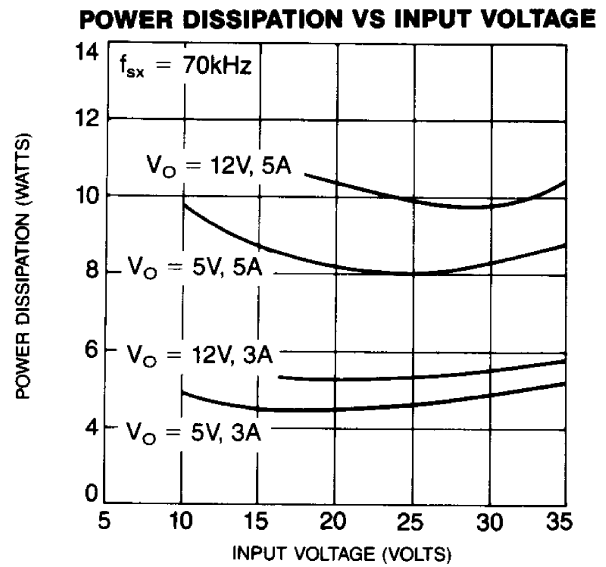
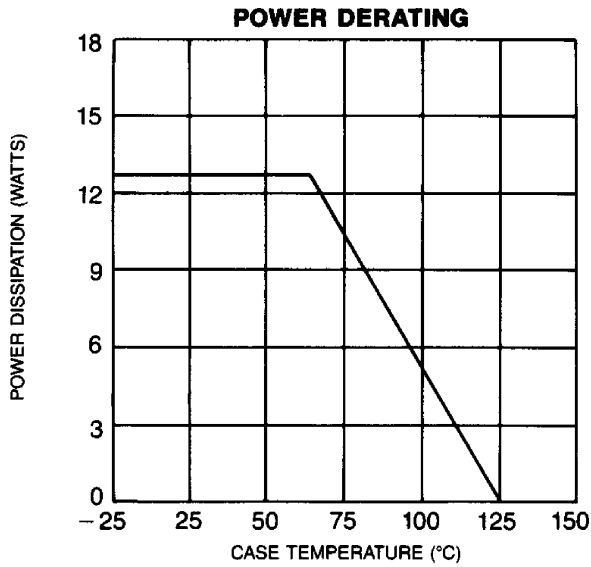

LSH 6355P

DEVICE OUTLINE

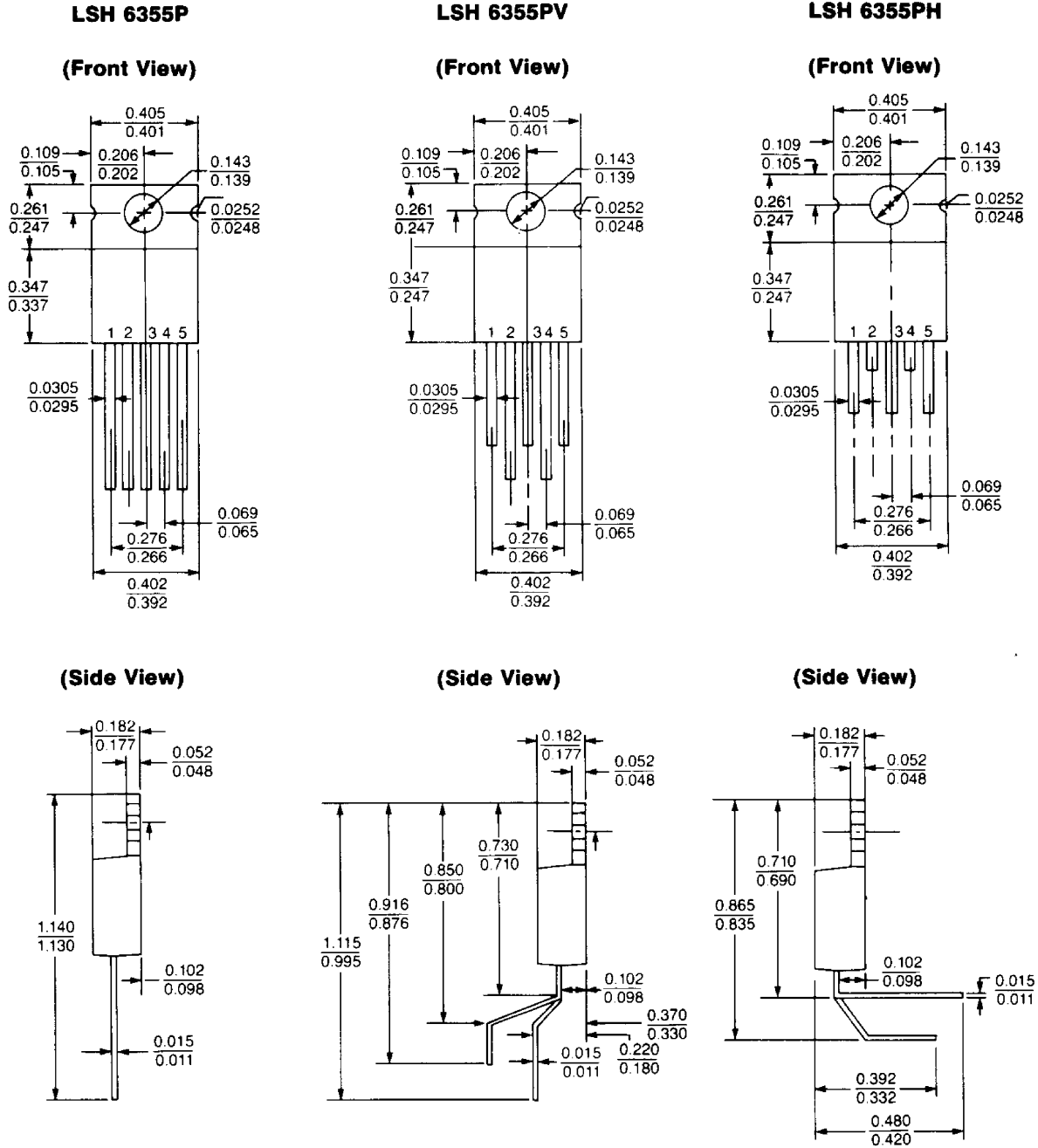

- | | | |
|---|---|----------------------------|
| 1 | - | V_{SENSE} |
| 2 | - | E_O |
| 3 | - | Small Signal Ground |
| 4 | - | Power Ground |
| 5 | - | Input |
| | | Tab is Small Signal Ground |